

# SPYCLOPS<sup>®</sup> PRO

## XVR

### Quick Start Guide

*Please read the Quick Start Guide fully before using the product and keep it for your records. Related tools and documents of products, please download from <http://www.metrahometheater.com>.*

# Statement

Thank you for purchasing our products, if you have any questions about setup or product use, please contact support. This manual is used for XVR's.

## Safety Precautions

1. Please modify default password immediately after the equipment is installed, to avoid unauthorized access.
2. Please do not place and install the equipment in direct sunlight or near heating equipment.
3. Please do not install the equipment in wet, dusty or locations with smoke.
4. Please keep the XVR installed level and secured to prevent the product from falling.
5. Do not drop or splash liquid onto the XVR and ensure that no liquid-filled items are placed on the device to prevent liquid from leaking into the device.
6. Please install the equipment in a well-ventilated area and do not block the vents of the equipment.
7. Please use the equipment within rated input/output range only.
8. Please do not disassemble the equipment without notifying supplier.
9. Please transport, use and store the equipment in climate controlled environment with regulated humidity and temperature.

## About

This manual is used as a guide. Pictures, charts, images and all other information provided are for description and explanation only. This manual's product descriptions and illustrations may vary from the actual products purchased.

Due to future product software upgrades or other design changes, Metra may update this manual. Please visit the company's official website for the latest version ([www.spyclopsusa.com](http://www.spyclopsusa.com)).

# XVR Quick Installation Guide

This XVR is convenient can be easily installed, plug and play and no complex setup needed.

## Installation Preparation

Install XVR hard drive. Make sure all power is disconnected before installing.

Installation tools: Phillips screwdriver

**(Please use surveillance grade hard disk drive only to avoid poor drive performance)**

(1) Unscrew the screws on the back and sides of the chassis and remove the cover.



(2) Connect one end of the hard disk power cable and SATA data cable to the motherboard and the other end to the hard disk.



(3) Align the hard disk screw holes to the chassis backplane, and then tighten the screws.











(4) Install the cover and re-attach with screws.



**Note: Images for instruction use only, your unit may look different but use the same methods**

## Interface Description

Icon	Name
	DC Power Input
	AC Power Input
	Power switch
	VGA
	HDMI
	Ethernet
	USB
A-IN	Audio Input
A-OUT	Audio Output
Alarm-IN	Alarm In
Alarm-OUT	Alarm Out
RS485	RS485
RS232	RS232
	BNC

## Connection Illustration

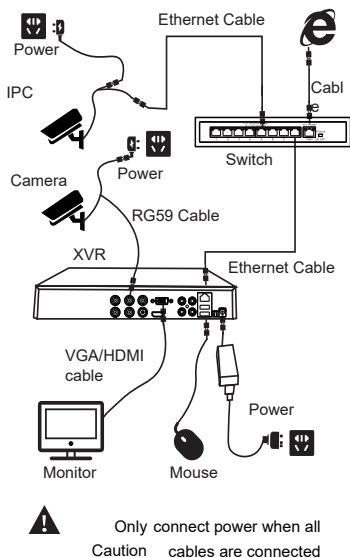

## Local Basic Operation

### Boot Up

Make sure the input voltage matches the XVR consumption. Connect the device to the monitor and to the power adapter (if available). Plug in the power, switch on the power button (if available), then the device will boot up.

#### NOTE:

1. It is recommended that you use only the included power supply.
2. You should reset the device administrator password (the system default username is "admin" and the password is "12345") when booting for the first time. To ensure the security of the device, please save the admin login password and modify it regularly.

## Modify Password

Step 1: After the device is powered on, select the system language, click "Apply", enter the password, click "Login", click "Modify".

Step 2: Enter the new password and confirm password, tick off the "Unlock Pattern" to draw twice the consistent unlock pattern consisting of 4-9 points.

Note: Images for instruction use only, your unit may look different but use the same methods

Step 3: Set the security question, select the security question 1, 2, 3 by the pull-down operation, and set the answer to the corresponding security question.

Step 4: Insert the USB flash drive into the device, and click "Export Key > Confirm > Save". The password is changed.

## Quick Configuration

After the device is powered on, the user can configure the system time, network configuration, format hard disk, channel addition and other parameters of the device through the Wizard.

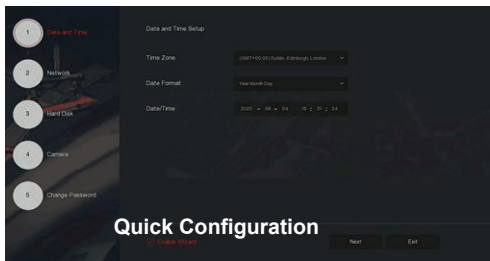

### NOTE:

The hard disk must be formatted when installing it for the first time.

## Network Configuration

Network parameters must be properly configured before operating the device over the network.

Step 1: On the preview interface, right-click to enter the menu, and click "  > TCP/IP".

Step 2: Modify the IP address of the device according to the actual network plan. (The default IP address of the XVR is 192.168.1.88).

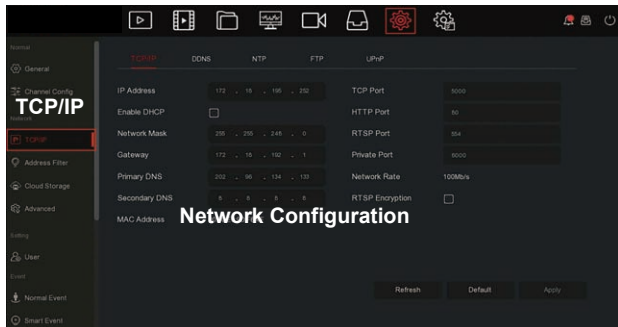



# Playback

## Instant playback

Step 1: On the preview interface, click the preview channel, the control bar will pop up below the channel.

Step 2: Click "🕒" to enter the instant playback interface, can play the first 5 minutes of the current channel video.

## Video playback

Step 1: On the preview interface, right-click to enter the menu, and click "🎬".

Step 2: Select "Channel > Date", the searched video is displayed on the time progress bar, click "▶" to start playing the video.



Note: Images for instruction use only, your unit may look different but use the same methods

## Normal Event

Step 1: On the preview interface, right-click to enter the menu, and click "⚙️ > Normal Event".

Step 2: Choose "Event Type > Channel > Enable" and set the corresponding alarm parameters. The device's normal event alarms include Motion Detection, Video Tampering, Video Loss, Alarm Input, Alarm Output, Exception, and Buzzer.

## Smart Event

Step 1: On the preview interface, right-click to enter the menu, and click "⚙️ > Smart Event".

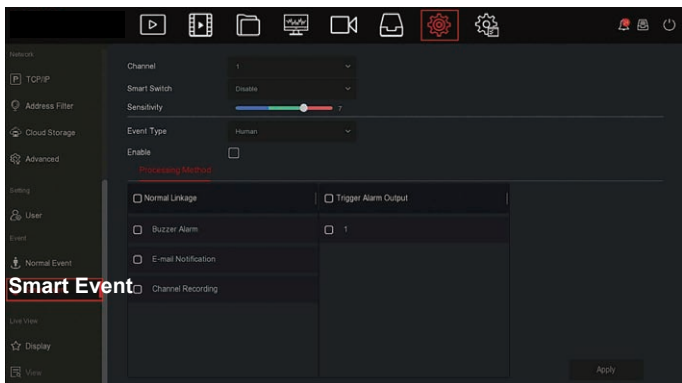

Step 2: Select the smart event alarm mode for setting the channel. Smart event alarms supported by the device include Human, Face, Face Comparison. Each smart detection can be configured with different alarm processing method.

**Note:** Images for instruction use only, your unit may look different but use the same methods



# Browser XVR Login

## 1. Login to XVR on LAN (PC & XVR connected to same router LAN)

1. Make sure the XVR and the connected PC (computer) are in the same segment. If not, please set IP address of your PC to the same segment as the XVR's, for example '192.168.1.33', but it must be different IP as the XVR's. ( Note: XVR default IP address is 192.168.1.88).
2. Open IE (Internet Explorer) browser, Select Tools > Internet Options > Safety > customized.
3. Open "Search Tool", double-click the target device from the search result to enter the login interface, or open the IE browser to enter the XVR address: such as http://192.168.1.88/ (If port 80 of the XVR is changed , you need to add the changed port) to enter the login interface.
4. On login interface, login to XVR (Notes: Default user: "admin",password: "12345").
5. Web page live view for XVR. On "Live Video" interface, click "Play" icon to play video.

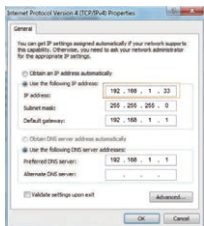

1

(Search Tool)

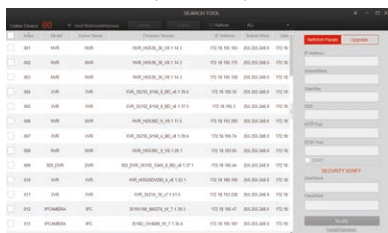

3

First connection will need to download and install



4



5-1



5-2

# Mobile App Access

Download and install SpyclopsPRO on a smart phone or tablet using either option below:

1. On the Android App Store or iPhone App Store enter "SpyclopsPRO" search, download and install.
2. Scan the following QR codes to download and install the App.



Android



iOS

Run the SpyclopsPRO App (new users need to register an account to log in first). The steps to add devices are as follows: To add with LAN Search method follow steps 1 - 9.2 and for QR scan replace 5.1 - 7.1 with 5.2 - 6.2.

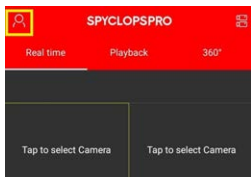

1

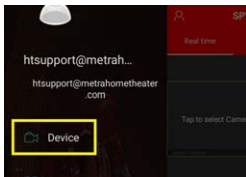

2

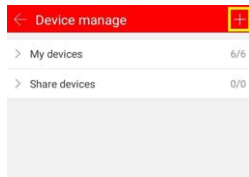

3

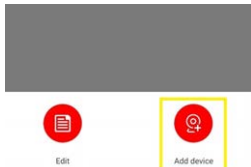

4

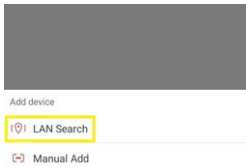

5.1



6.1



7.1



8.1



9.1



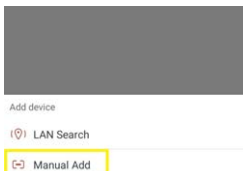

9.2



5.2



6.2

1. Tap  in the upper left menu
2. Tap "Device"
3. Tap  upper right menu bar;
4. Tap "Add device"
- 5.1 Tap LAN Search menu
- 6.1 Tap LAN Search button 7.1 Tap on the found devices

- 8.1 Tap the device you would like to add
- 9.1 Enter the username and password and tap Done.
- 9.2 Enter your choice of Device name, select the group you would like to add to and tap "Finish" in the upper right. The device will now be found in "My Devices"
- 5.2 Tap "Manual Add"
- 6.2 Enter Serial Number manually (Or tap scan icon in upper right and scan SN QR code on label), Your choice of Device name, Username, Password and Tap Save.

### How to setup app for live view:

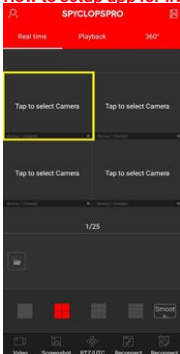

1

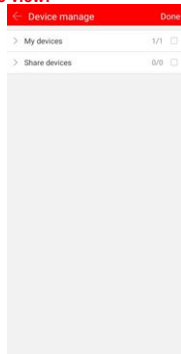

2



3

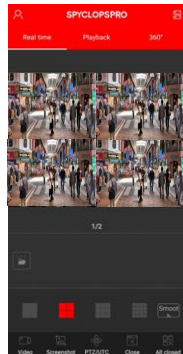

4

1. Tap "Tap to select Camera"
2. Tap "My devices"
3. Tap the check box for the NVR/XVR to add all cameras or tap individual cameras and tap "Done"
4. Enjoy your live view cameras!

## How to playback recorded videos with app

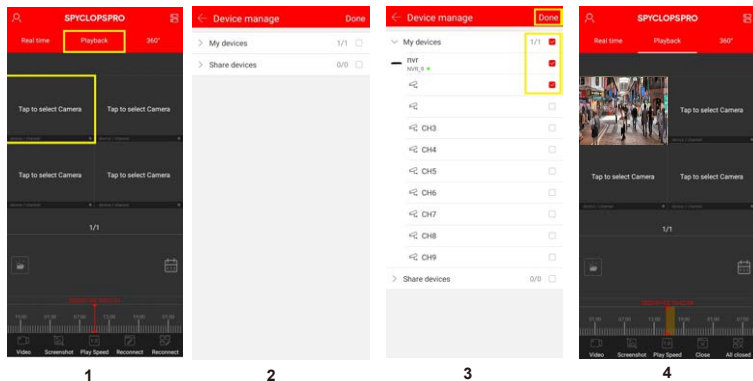

1. Tap "Tap to select Camera"
2. Tap "My devices"
3. Tap the check box for the camera to view recorded videos and tap "Done"
4. Swipe left or right on the time line to change the recording time view.

Note: Green bars are recording from schedule and Red is from motion detection.