



Audi (with MMI radio*) HDMI and Camera Interface 2008-2012

* For vehicles with: 3 Basic 6.5-inch screen, 3G/3G+ 7-inch screen

INTERFACE FEATURES

- Provides front and rear camera inputs to the factory display screen
- Provides an HDMI input to the factory display screen
- Micro “B” USB updatable

INTERFACE COMPONENTS

- AX-AM-AU96 interface
- AX-AM-AU96 harness (new style)
- AX-AM-AU96 harness (old style)
- 20-pin “T” harness
- 6-pin to 4-pin LVDS (video) cable
- 10-pin harness with RCA jacks

APPLICATIONS

AUDI

A4 (Typ 8K)	2009-2012	Q5 (Typ B6)	2009-2012
A5 (Typ B8)	2009-2012	Q7 (Typ 4L)	2009-2012
A6 (Typ C6/C7)	2008-2012	A8 (Typ D4)	2008-2012

TABLE OF CONTENTS

Connections to be made	2
Configuring the AX-AM-AU96	3
Installing the AX-AM-AU96	4
User guide	5

TOOLS REQUIRED

- Wire cutter • Crimp tool • Solder gun • Tape
- Connectors (example: butt-connectors, bell caps, etc.)

CAUTION! All accessories, switches, climate controls panels, and especially air bag indicator lights must be connected before cycling the ignition. Also, do not remove the factory radio with the key in the on position, or while the vehicle is running.

CONNECTIONS TO BE MADE

- If installing a front/rear camera, connect the **Black** wire labeled “GND”, to the camera(s) ground wire.
- If installing a backup camera, connect the **Red** wire labeled “Reverse Camera 12v”, to the backup camera power wire.
- If installing a front camera, connect the **Red** wire labeled “Front Camera 12v”, to the front camera power wire.
- The **Red** wire labeled “Acc Power Output” is optional if a power source is required while a camera is active.
- If installing a backup camera, connect the RCA jack labeled “Reverse Camera Video Input” to the camera.
- If installing a front camera, connect the RCA jack labeled “Front Camera Video Input” to the camera.
- If adding an HDMI input to the factory display screen, connect an HDMI cable (Axxess part number AX-HDCABLE, sold separately), to the port on the AX-AM-AU96 labeled “HDMI IN”.

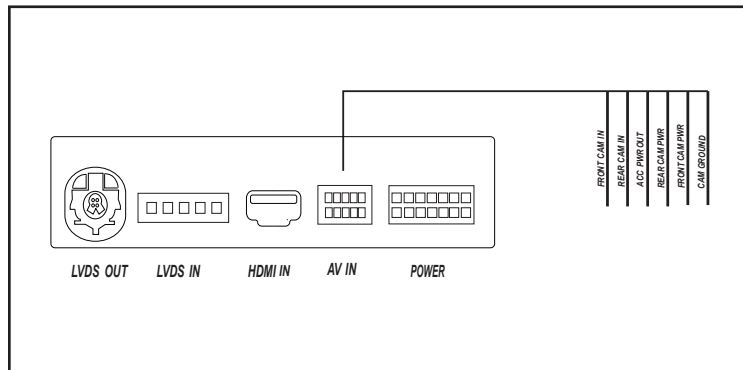

(Connections Diagram)

CONFIGURING THE AX-AM-AU96

Dip switch settings

Remove the access door located on the top of the AX-AM-AU96 interface to access the dip switches.

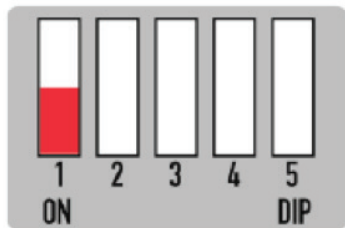

Dip 1

If the vehicle is equipped with a factory backup camera: **On:** Yes **Off:** No

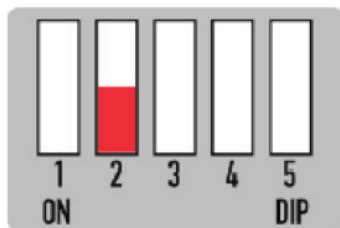

Dip 2

If the vehicle has an aftermarket front camera: **On:** Yes **Off:** No

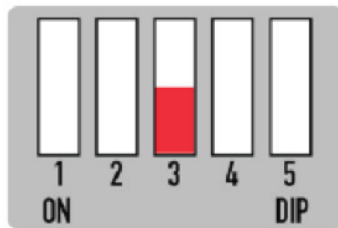

Dip 3

If the vehicle has an aftermarket backup camera: **On:** Yes **Off:** No

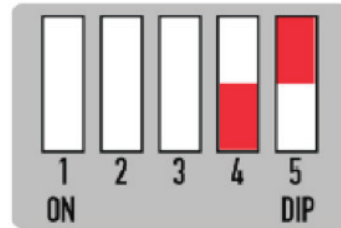

Dips 4 & 5

- Small screen (low resolution 400 x 240): Dip 4 On
- Large screen (high resolution 800 x 480): Dip 4 Off
- Fakra A harness (new style): Dip 5 On
- Fakra B harness (old style): Dip 5 Off

INSTALLING THE AX-AM-AU96

- Remove the main connector from the media player (CD or DVD player), then connect the *male* plug from the AX-AM-AU96 harness into the media player. (Figure A, connection 1)

Note: For the A6 and A8, the media player is located in the glovebox, the left media player (there will be two media players there).

Note: There are (2) different main harnesses included with the AX-AM-AU96. Use the one that connects to the vehicle and disregard the other one.

- Connect the factory *male* factory connector into the *female* plug from the AX-AM-AU96 harness.
- Connect the AX-AM-AU96 harness into the AX-AM-AU96 interface.
- Remove the LVDS (video) cable from the radio, then connect it to the AX-AM-AU96 interface (LVDS OUT). (Figure A, connection 2)

Note: This factory connector may be gray or yellow.

- Connect the 6-pin to 4-pin LVDS (video) cable into the radio, and then into the AX-AM-AU96 interface (LVDS IN).
- Remove the 20-pin connector from the climate control, then connect the *male* plug from the 20-pin "T" harness into the climate control. (Figure B)
- Connect the factory *male* factory connector into the *female* plug from the 20-pin "T" harness.
- Connect the 2-pin connector from the 20-pin "T" harness to the AX-AM-AU96 harness.
- Connect the 10-pin harness with RCA jacks into the AX-AM-AU96 interface.

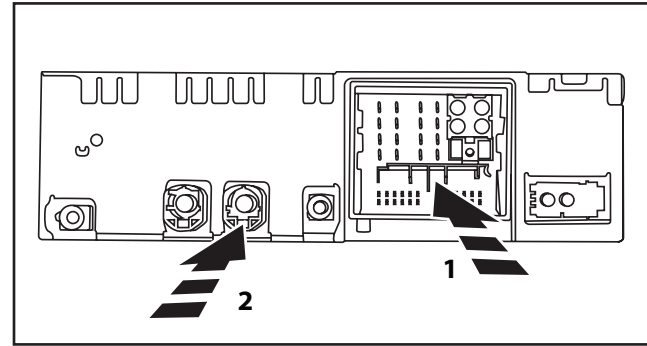

(Figure A)

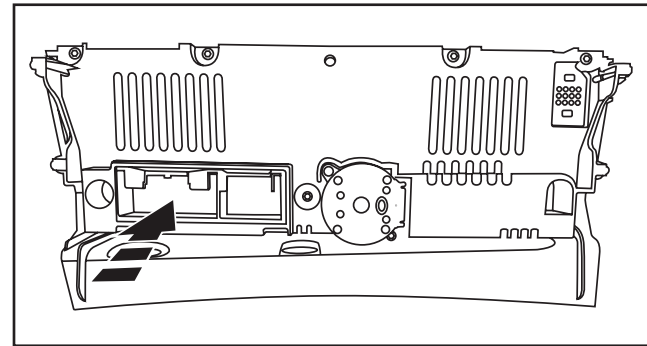

(Figure B)

Button Configuration



MMI Type 1 (Return Button)



MMI Type 2 (Back Button)

HDMI access

To activate AUX-IN, an “AMI to 3.5mm AUX cable” will be required (not included).

- Select AUX-IN as a source from the factory radio.
- Press and hold the “RETURN/BACK” button for 2 seconds to switch between the factory screen and the AX-AM-AU96 screen.
- Double tap the “RETURN/BACK” button to disable the video-in-motion warning message.

Rear camera access

- The backup camera will automatically activate while the vehicle is in reverse gear.
- Deselecting the reverse gear will activate the front camera, if installed and dip switch 2 is selected to “ON”.

Note: This camera takes priority over HDMI mode, and front camera mode. But will not deactivate the front camera. Double tap the “RETURN/BACK” button, or drive over 10 mph, to cancel front camera mode.

Front camera access

- Ensure dip switch 2 is selected to “ON”.
- Press and hold the “RETURN/BACK” button for 2 seconds to activate the front camera.

View Version Number

- Press and hold the “RETURN/BACK” button for 8 seconds to enter the firmware information screen.



AX-AM-AU96

INSTALLATION INSTRUCTIONS



IMPORTANT

If you are having difficulties with the installation of this product, please call our Tech Support line at 1-800-253-TECH. Before doing so, look over the instructions a second time, and make sure the installation was performed exactly as the instructions are stated. Please have the vehicle apart and ready to perform troubleshooting steps before calling.



KNOWLEDGE IS POWER

Enhance your installation and fabrication skills by enrolling in the most recognized and respected mobile electronics school in our industry. Log onto www.installerinstitute.com or call 800-354-6782 for more information and take steps toward a better tomorrow.



Metra recommends MECP certified technicians