



### Audi A1 (Typ 8X) (with Concert Radio) HDMI and Camera Interface 2010-up\*

\*Visit [AxxessInterfaces.com](http://AxxessInterfaces.com) for up-to-date vehicle specific applications.

#### INTERFACE FEATURES

- Provides front and rear camera inputs to the factory display screen
- Provides an HDMI input to the factory display screen \*
- Micro “B” USB updatable

\* The factory radio must have an AUX input

#### INTERFACE COMPONENTS

- AX-AM-AU95 interface
- AX-AM-AU95 harness (new style)
- AX-AM-AU95 harness (old style)
- 20-pin “T” harness
- 6-pin to 4-pin LVDS (video) cable
- 10-pin harness with RCA jacks

#### TABLE OF CONTENTS

Connections to be made .....	2
Configuring the AX-AM-AU95 .....	3
Installing the AX-AM-AU95.....	4
User guide.....	5

#### TOOLS REQUIRED

- Wire cutter • Crimp tool • Solder gun • Tape
- Connectors (example: butt-connectors, bell caps, etc.)

**CAUTION!** All accessories, switches, climate controls panels, and especially air bag indicator lights must be connected before cycling the ignition. Also, do not remove the factory radio with the key in the on position, or while the vehicle is running.

## CONNECTIONS TO BE MADE

- If installing a front/rear camera, connect the **Black** wire labeled “GND”, to the camera(s) ground wire.
- If installing a backup camera, connect the **Red** wire labeled “Reverse Camera 12v”, to the backup camera power wire.
- If installing a front camera, connect the **Red** wire labeled “Front Camera 12v”, to the front camera power wire.
- The **Red** wire labeled “Acc Power Output” is optional if a power source is required while a camera is active.
- If installing a backup camera, connect the RCA jack labeled “Reverse Camera Video Input” to the camera.
- If installing a front camera, connect the RCA jack labeled “Front Camera Video Input” to the camera.
- If adding an HDMI input to the factory display screen, connect an HDMI cable (Axxess part number AX-HDCABLE, sold separately), to the port on the AX-AM-AU95 labeled “HDMI IN”.

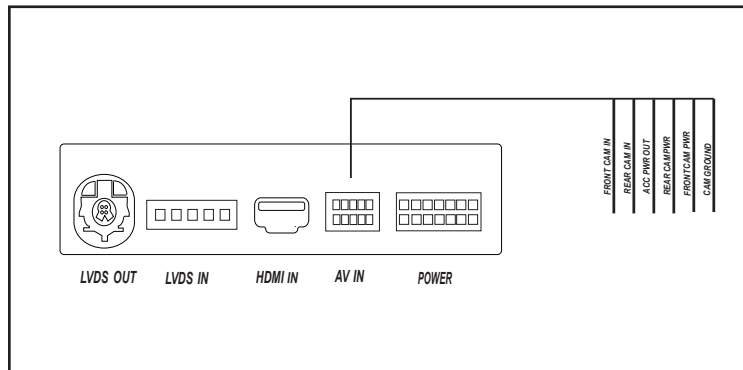

(Connections Diagram)

## CONFIGURING THE AX-AM-AU95

### Dip switch settings

Remove the access door located on the top of the AX-AM-AU95 interface to access the dip switches.

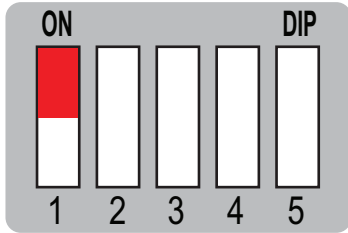

#### Dip 1

If the vehicle is equipped with a factory backup camera: **On:** Yes **Off:** No

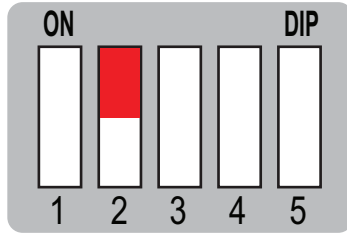

#### Dip 2

If the vehicle has an aftermarket front camera: **On:** Yes **Off:** No

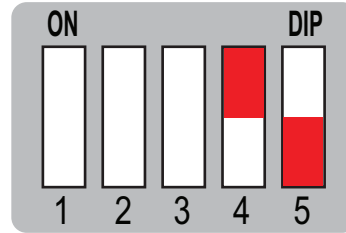

#### Dip 3

If the vehicle has an aftermarket backup camera: **On:** Yes **Off:** No

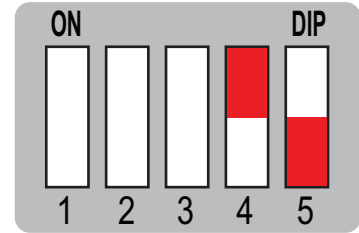

#### Dips 4 & 5

For the Audi A1:

**Dip 4:** On **Dip 5:** Off

## INSTALLING THE AX-AM-AU95

- Remove the main connector from the radio, then connect the *male* plug from the AX-AM-AU95 harness into the radio. (Figure A)

**Note:** There are (2) different main harnesses included with the AX-AM-AU95. Use the one that connects to the vehicle and disregard the other one.

- Connect the factory *male* factory connector into the *female* plug from the AX-AM-AU95 harness.
- Connect the AX-AM-AU95 harness into the AX-AM-AU95 interface.
- Remove the LVDS (video) cable from the radio, then connect it to the AX-AM-AU95 interface (LVDS OUT). (Figure A)
- Connect the 6-pin to 4-pin LVDS (video) cable into the radio, and then into the AX-AM-AU95 interface (LVDS IN).
- Remove the 20-pin connector from the climate control, then connect the *male* plug from the 20-pin "T" harness into the climate control. (Figure B)
- Connect the factory *male* factory connector into the *female* plug from the 20-pin "T" harness.
- Connect the 2-pin connector from the 20-pin "T" harness to the AX-AM-AU95 harness.
- Connect the 10-pin harness with RCA jacks into the AX-AM-AU95 interface.

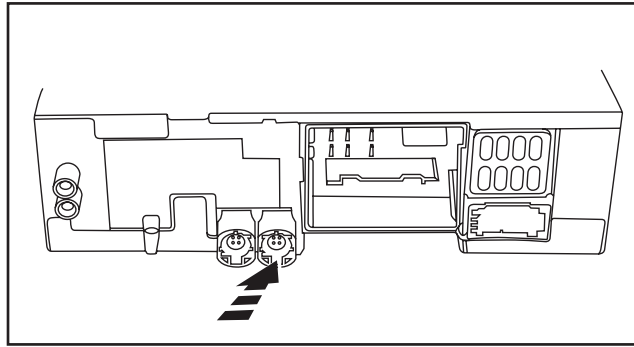

(Figure A)

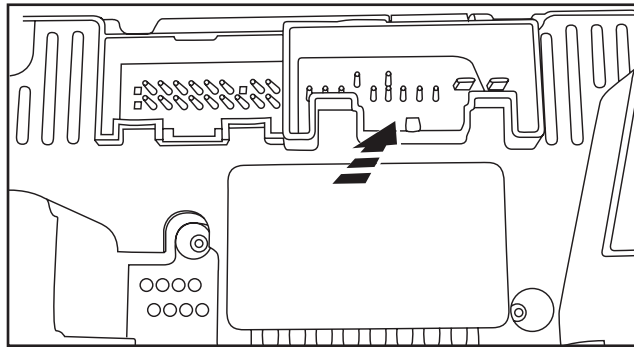

(Figure B)

## Button Configuration

- There are (3) different sets of factory buttons used to operate the AX-AM-AU95 depending on the trim level of the vehicle.



*Type 1*



*Type 2*



*Without Steering  
Wheel Controls*

## HDMI access

- Select AUX-IN as a source from the factory radio.
- Press and hold button “A” for 2 seconds to switch between the factory screen and the AX-AM-AU95 screen.
- Press button “A” to disable the video-in-motion warning message.

## Front camera access

- Ensure dip switch 2 is selected to “ON”.
- Press and hold button “B” for 2 seconds to activate the front camera.

## Rear camera access

- The backup camera will automatically activate while the vehicle is in reverse gear.
- Deselecting the reverse gear will activate the front camera, if installed and dip switch 2 is selected to “ON”.

**Note:** This camera takes priority over HDMI mode, and front camera mode. But will not deactivate the front camera. The front camera image will disappear after the vehicle reaches 10 mph.

## View Version Number

- Press and hold button “A” for 8 seconds to enter the firmware information screen.



---

---

---

---

---

---

---

---

---

---

---

---

---

---

---

---

---

---

---

---

---

---

---

---

---

---

---

---

---

---

---

---

---

---

---

---

---

---

---

---

---

---

---

---

---

---

---

---

---

---

---

---

---

---

---

---

---

---

---

---



---

---

---

---

---

---

---

---

---

---

---

---

---

---

---

---

---

---

---

---

---

---

---

---

---

---

---

---

---

---

---

---

---

---

---

---

---

---

---

---

---

---

---

---

---

---



# AX-AM-AU95

INSTALLATION INSTRUCTIONS



### IMPORTANT

*If you are having difficulties with the installation of this product, please call our Tech Support line at 1-800-253-TECH. Before doing so, look over the instructions a second time, and make sure the installation was performed exactly as the instructions are stated. Please have the vehicle apart and ready to perform troubleshooting steps before calling.*



### KNOWLEDGE IS POWER

Enhance your installation and fabrication skills by enrolling in the most recognized and respected mobile electronics school in our industry. Log onto [www.installerinstitute.com](http://www.installerinstitute.com) or call 800-354-6782 for more information and take steps toward a better tomorrow.



**Metra recommends MECP certified technicians**